

DETAILS OF PANEL - TYPE 200

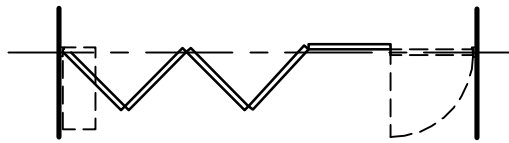

1. END FOLD - SINGLE.



2. CENTRE FOLD - SINGLE.

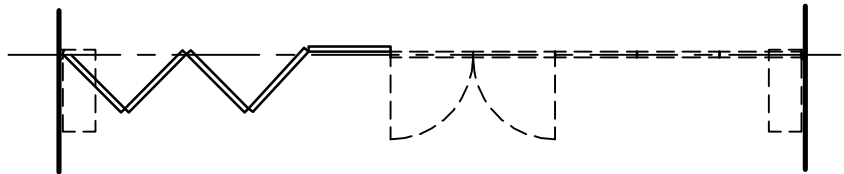

3. END FOLD - BI-PARTING

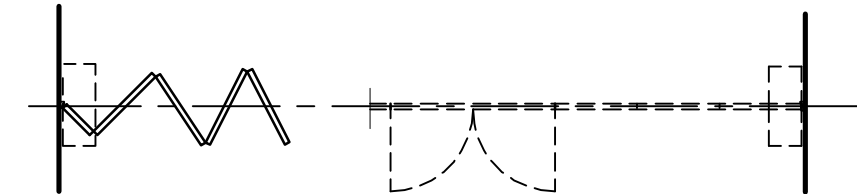

4. CENTRE FOLD - BI-PARTING

LAYOUT TYPES

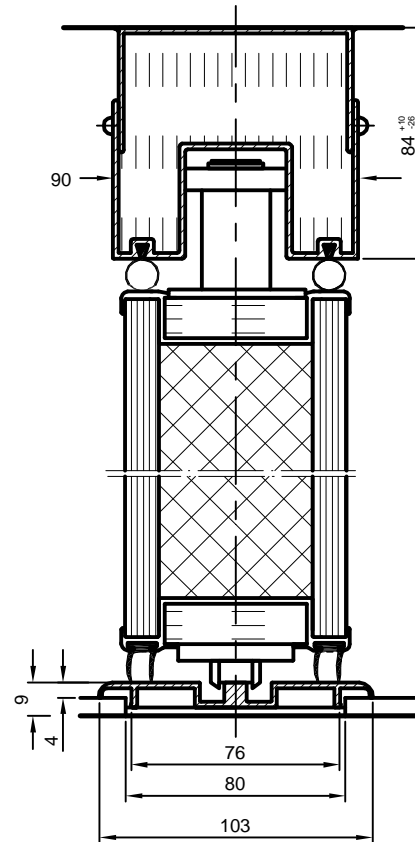

VERTICAL SECTION

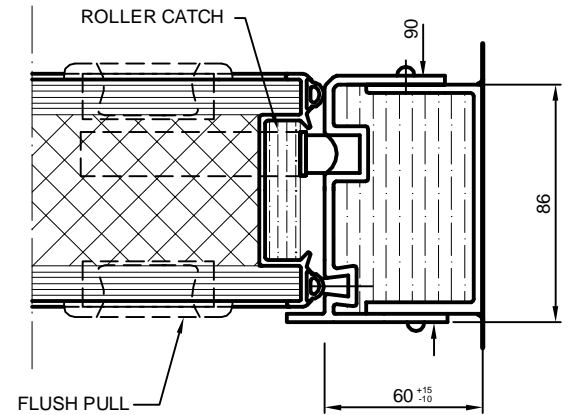
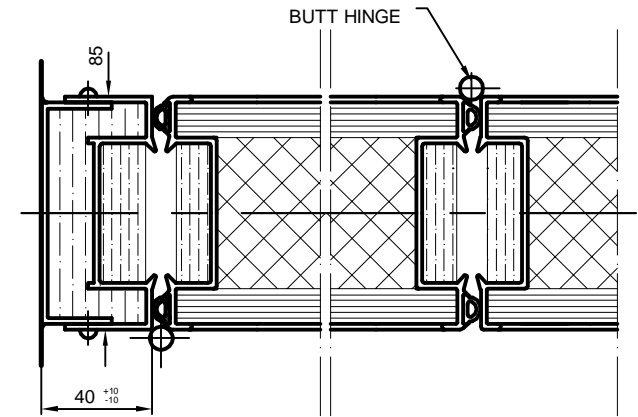

HORIZONTAL SECTION - WALL JAMB

MOVAWALL
ACOUSTIC SLIDING

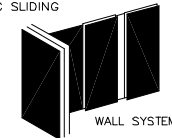

MOVAWALL SYSTEMS LTD

63 BARWELL BUSINESS PARK
LEATHERHEAD ROAD
CHESSINGTON
SURREY
KT9 2NY

TELEPHONE: +44 (0) 20 8391 8790

FAX: +44 (0) 20 8391 8791

EMAIL: info@movawall.co.uk

DRG. NO.: SL - 201